

DELTA ELEVATOR

In MACHINE ROOM J-BOX

OSIA3

NOTE: SMOKE SENSORS REQUIRED WHEN TRAVEL IS OVER 25 FEET.

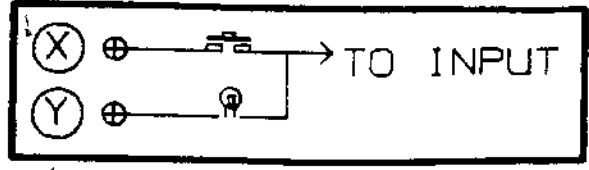
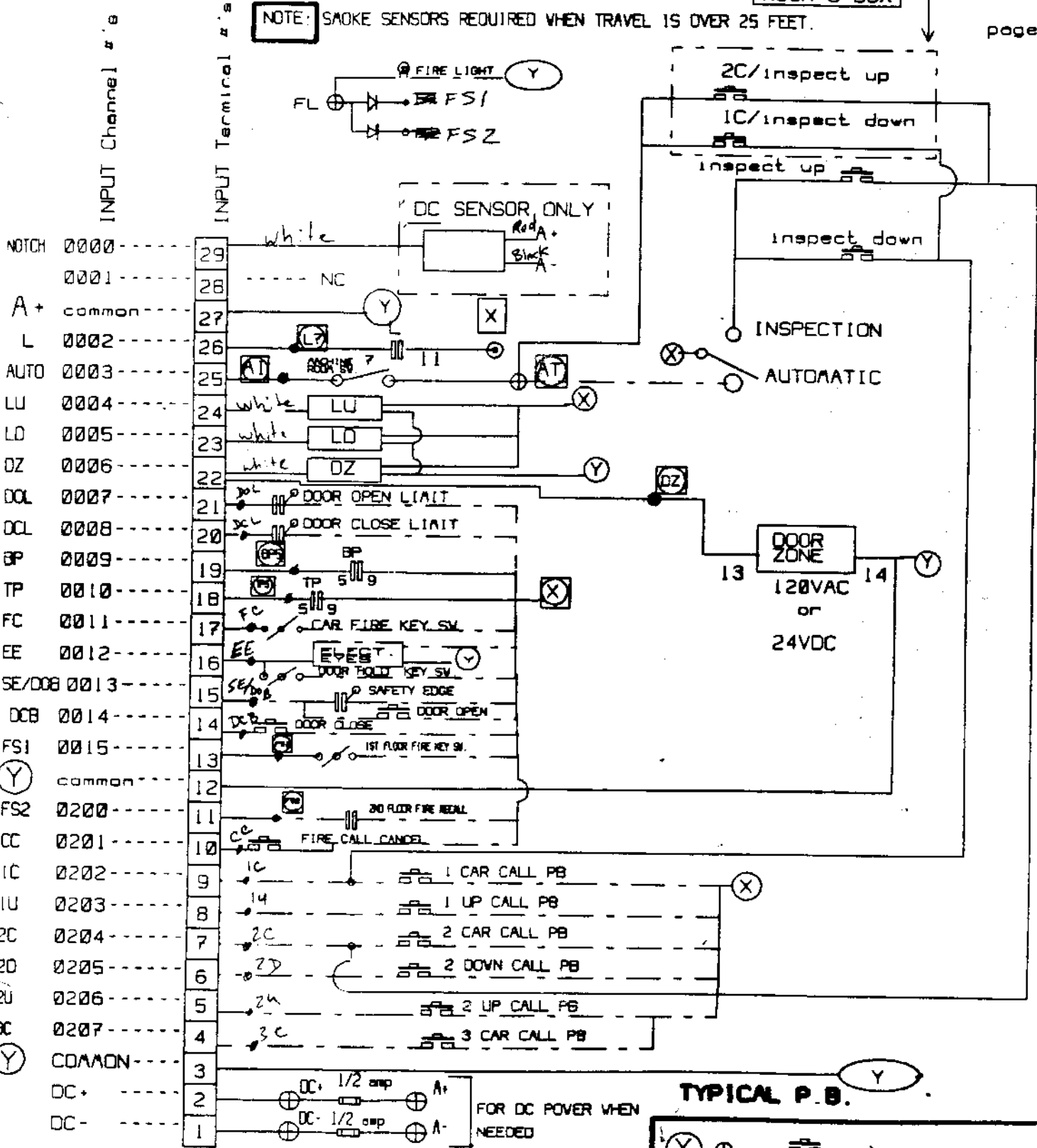

DELTA ELEVATOR

emlt

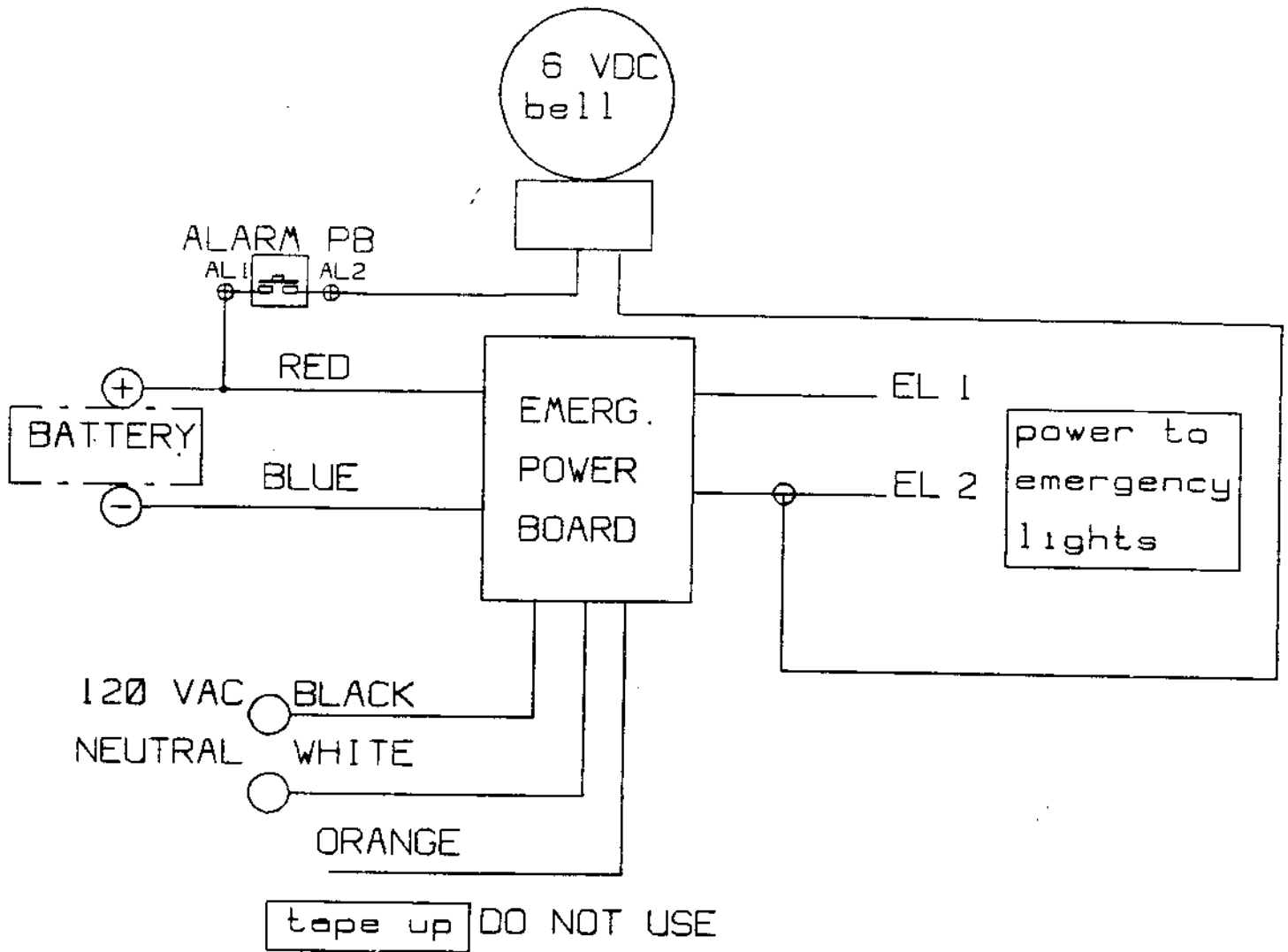

11-22-88

DELTA ELEVATOR

OTB

CAR TRAVELING CABLE H J B LOOM WIRE MACHINE ROOM

1	1	1	1	1
OZ	2	OZ	2	OZ
CG	3	CG	3	CG
L-7	4	L-7	4	L-7
BP-5	5	BP-5	5	BP-5
TP-5	6	TP-5	6	TP-5
0104	7	0104	7	0104
0105	8	0105	8	0105
0100	9	0100	9	0100
0107	10	0107	10	0107
AT	11	AT	11	AT
AI	12	AI	12	AI
IC	13	IC	13	IC
2C	14	2C	14	2C
A+	15	A+	15	A+
A-	16	A-	16	A-
L1A	17	L1A	17	L1A
L2A	18	L2A	18	L2A
L3A	19	L3A	19	L3A
FS1	20	FS1	20	FS1
FS2	21	FS2	21	FS2
3A	22	3A	22	3A
4	23	4	23	4
5	24	5	24	5
6	25	6	25	6
10	26	10	26	10
BP	27	BP	27	BP
TP	28	TP	28	TP
L	29	L	29	L
P-0	30	P-0	30	
P-1	31	P-1	31	
P-2	32	P-2	32	
P-3	33	P-3	33	
P-4	34	P-4	34	
P-5	35	P-5	35	
P-6	36	P-6	36	
1U	37	1U	37	
2U	38	2U	38	
3U	39	3U	39	
4U	40	4U	40	
5U	41	5U	41	
6U	42	6U	42	
7U	43	7U	43	
8U	44	8U	44	
9U	45	9U	45	
0U	46	0U	46	

2
3
HS
TPB
TP12
UH
OH
ACC
L1
L2
L3

MACHINE ROOM ONLY

L20 WHITE 14 GA. WIRE
L10 BLACK 14 GA. WIRE
TEL-1 BLACK OF BLACK/WHITE PAIR
TEL-2 WHITE OF BLACK/WHITE PAIR
L20 WHITE 14 GAUGE WIRE TO WIRE NUT
L10 BLACK 14 GAUGE WIRE TO WIRE NUT
TEL-1 31 WIRE NUT TO PHONE WIRE
TEL-2 32 WIRE NUT TO PHONE WIRE

NEUTRAL LEAD
HOT LEAD

- AI
- A2
- FI
- F2
- AL-1
- AL-2
- EL-1
- EL-2
- FL
- OCB
- OOL
- DCL
- FC
- EE
- SE/OOB
- CC
- 0100
- 0100

car top ONLY

CTCONTROL

the C4K-10 and the C4K-OR2 are used on a three stop

TERMINAL WIRE #	1	2	3	4	5	6
	2C	1C	AC	1	AT	X

X - *use for A*
 USE AC on C4K-CAR-A
 USE A- on C4K-COR-A

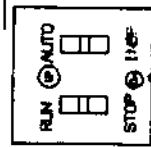
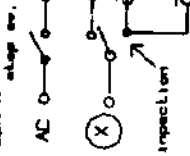

ADJUSTED WITH 17 INCH DIN RAIL 4 INCHES FROM EDGE AND 4 INCHES DOWN FROM THE TOP

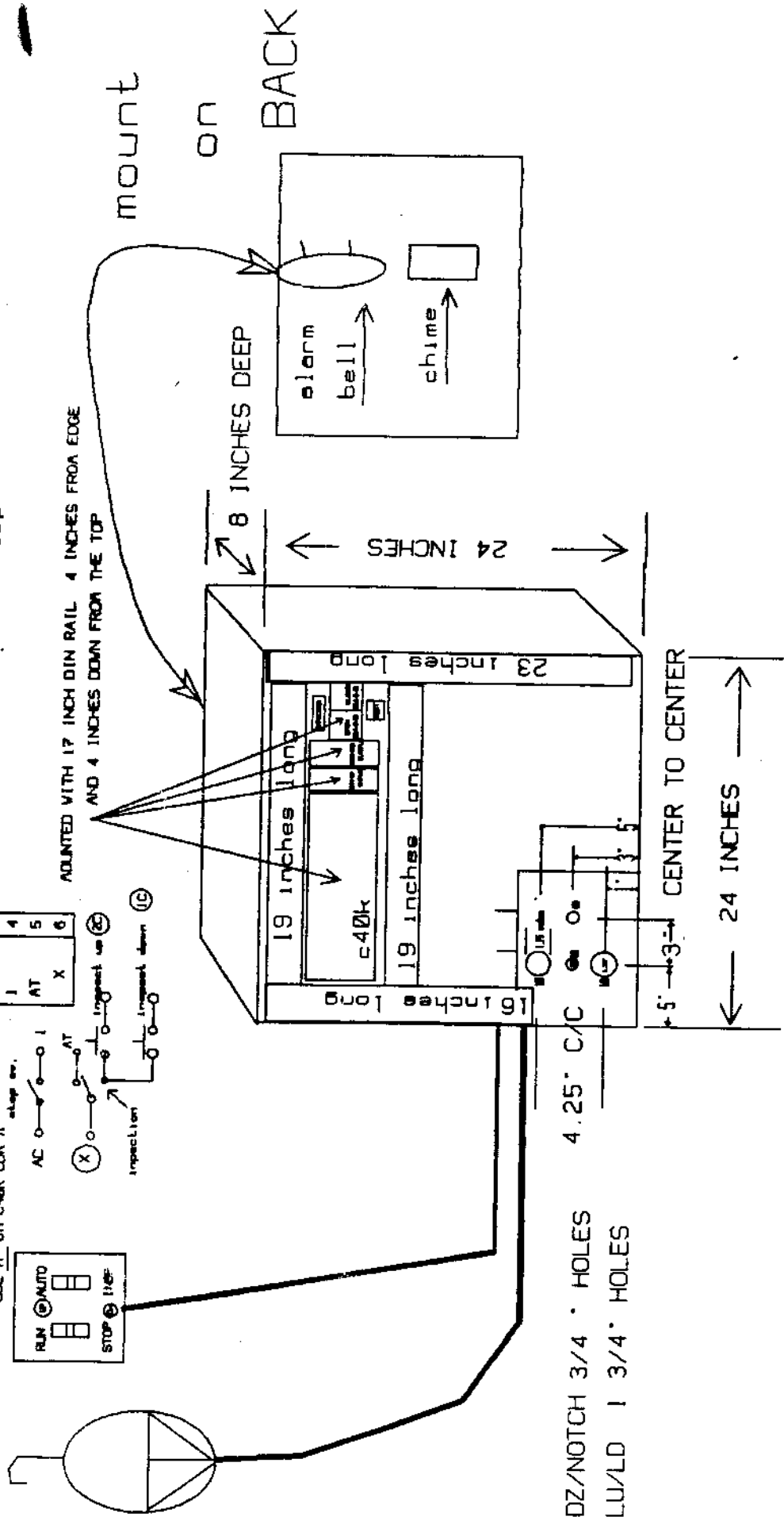

mount on BACK

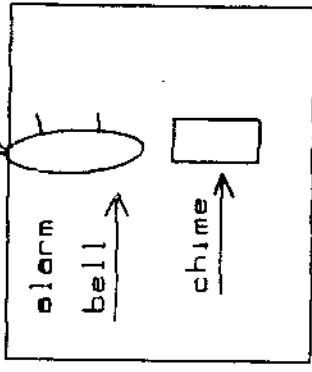

DZ/NOTCH 3/4" HOLES
 LU/LD 1 3/4" HOLES



12 TERMINALS - 2 STOP
 ADD 1 TERMINAL FOR EACH FLOOR OVER A 2 STOP

11-22-88

DELTA ELEVATOR

OCAR

CAR TOP CONTROLER TO

CAR STATION

P. I.

SAFETY EDGE & ELECTRIC EYE

CAR DIRECTIONAL ARROWS

WIRE#

- 1 A+
- 2 A-
- 3 AL-1
- 4 AL-2
- 5 1C
- 6 2C
- 7 3C
- 8 4C
- 9 5C
- 10 6C
- 11 DOB
- 12 DCB
- 13 CC
- 14 FC
- 15 FL
- 16 EE
- 17 CAB LIGHT SW.
- 18 CAB FAN SW.
- 19 TEL-1
- 20 TEL-2

WIRE#

- 21 P-0
- 22 P-1
- 23 P-2
- 24 P-3
- 25 P-4
- 26 P-5
- 27 P-6
- 28 A+

WIRE#

- 29 A+
- 30 A-
- 31 EE
- 32 SE

WIRE#

- 33 AC
- 34 0108-UP ARROW
- 35 0109-DOWN ARROW

BLK-L10 HOT FED FOR 120 vac
 White-L20 NEUTRAL FED TO CAB LIGHTS AND FAN

DOOR OPERATOR AND CAR GATE

- 41 A1
- 42 A2
- 43 F1
- 44 F2
- 45 CG CAR GATE
- 36 L HATCH LOCKS
- 37 DOL DOOR OPEN LIMIT
- 38 DCL DOOR CLOSE LIMIT
- 39 A-

40- Spare wire

11-22-88

DELTA ELEVATOR

DOOR

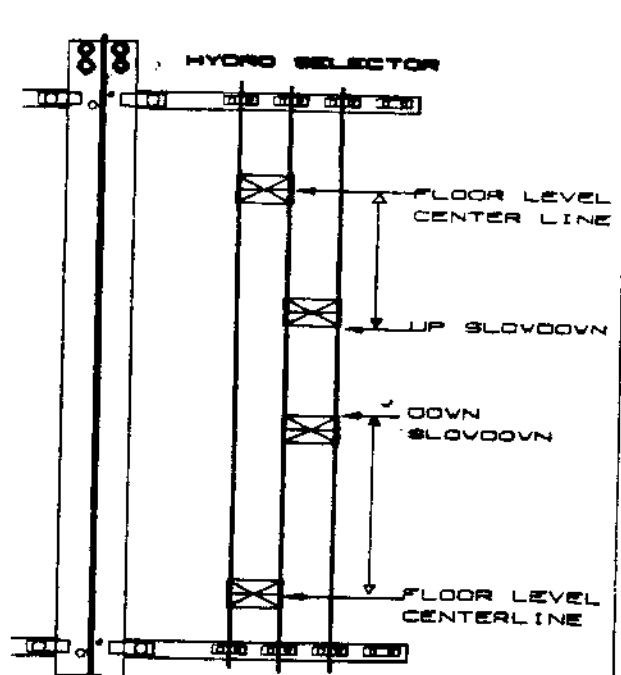
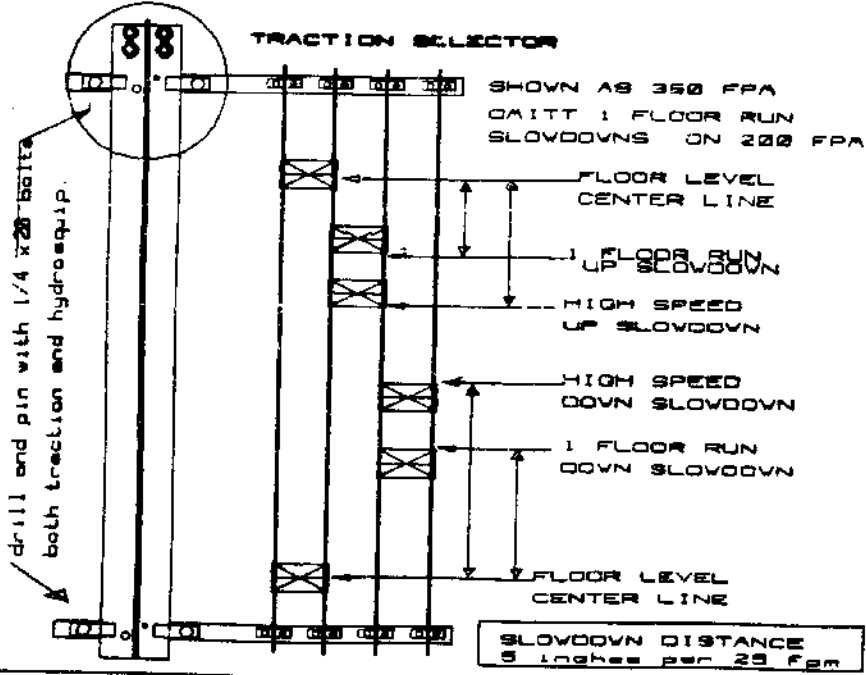
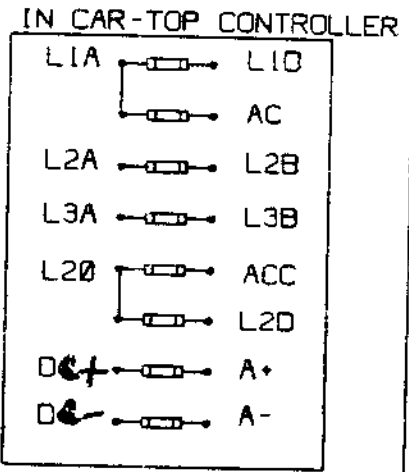
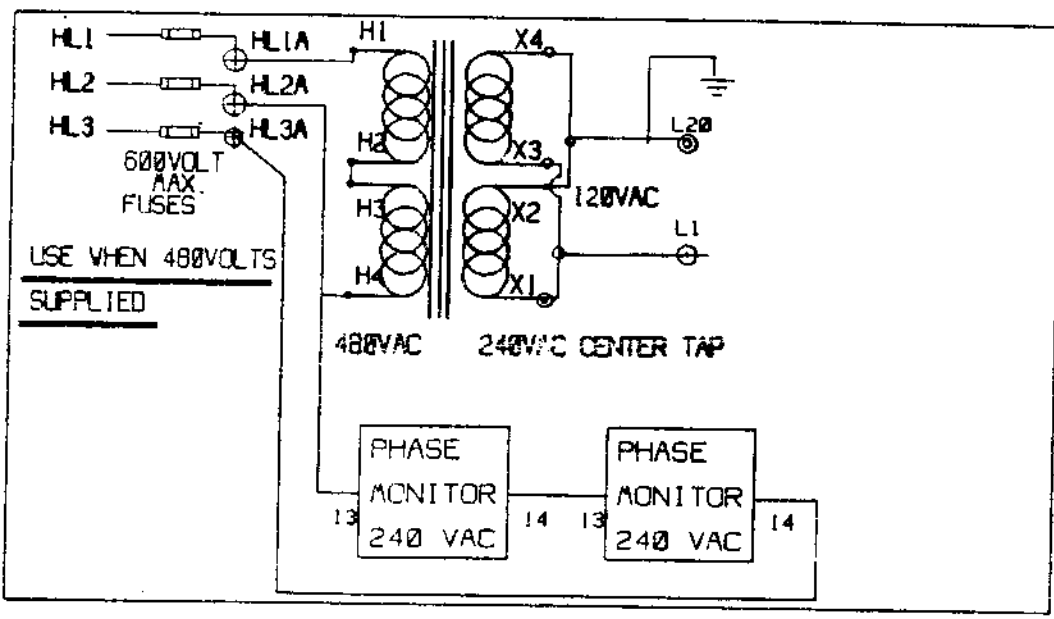
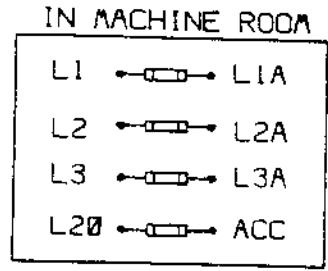
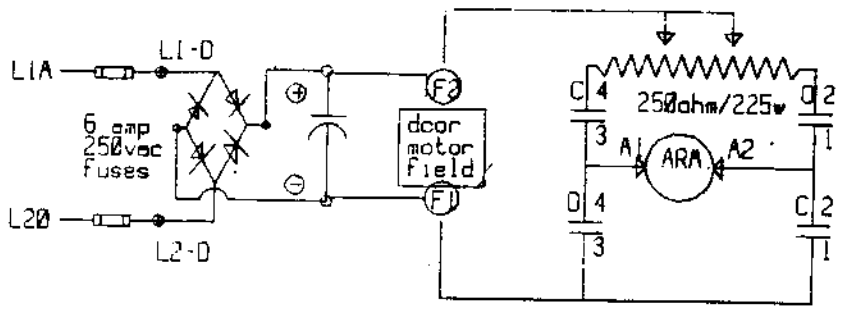

11-22-88

DELTA ELEVATOR

OCT

omron connection table
CAR TO MACHINE ROOM

INPUT	OUTPUT	CAR TERMINAL	MACHINE ROOM TERM.	NAME	WIRE NUMBER
		L2A	L2A	L2A	1 YELLOW
		L3A	L3A	L3A	2 YELLOW
		AC	AC	AC	3 YELLOW
		ACC	ACC	ACC	4 YELLOW
		A-	A-	A- USED ON DC	5 YELLOW
		A+	A+	A+ USED ON DC	6 YELLOW
0002		L7	L7	LOCKS	7 YELLOW
		AT	AT	AUTO-TERMINAL	8 YELLOW
0003		AL	AL	AUTO-INPUT	9 YELLOW
0015		FS1	FS1	FIRE SERV. 1	10 YELLOW
0200		FS2	FS2	FIRE SERV. 2	11 ORANGE
	0107	0107	0107	HIGH SPEED COIL	12 ORANGE
	0105	0105	0105	UP LEV. COIL	13 ORANGE
	0106	0106	0106	DN LEV. COIL	14 ORANGE
	0104	0104	0104	STARTER COIL	15 ORANGE
0010		TP5	TP5	TP RESET	16 ORANGE
0009		BP5	BP5	BP RESET	17 ORANGE
		CG	CG	CAR GATE	18 ORANGE
0202		IC	IC	IC & INSP. Dn	19 ORANGE
0204		2C	2C	2C & INSP. Up	20 ORANGE
0203		1U	1U	1 UP CALL	21 BROWN
0205		2D	2D	2 Dn CALL	22 BROWN
0206		2U	2U	2 UP CALL	23 BROWN
0400		3D	3D	3 Dn Call	24 BROWN
		I	I	CAR TOP STOP SV.	25 BROWN
	0102	1PL P-0	1PL P-0	1 POS. LIGHT	26 BROWN
	0300	2PL P-1	2PL P-1	2 POS. LIGHT	27 BROWN
	0500	3PL P-2	3PL P-2	3 POS LIGHT	28 BROWN
		^	P-3		29 BROWN
			P-4		30 BROWN
			P-5		31 BLUE
			P-6		32 BLUE
		L	L	LOCKS	33 BLUE

MACHINE ROOM TO HATCH

14 MULTICONDUCTOR CABLES

CABLES	#1	#2
X - PB/FI		1
Y - PB/FI		2
4 - BOTT LOCK	6	
L - TOP LOCK	1	
3A - PIT SW.	13	
4 - PIT SW.	14	
5 - UP LIM.	5	
5 - Dn LIM.	12	
8 - UP LIM.	4	
8 - UP S.O.	3	
10 - Dn Lim.	11	
10 - Dn S.O.	10	
TP - Up S.O.	2	
BP - Dn S.O.	9	
FS1 - 1st PB		3
FS2 - 1st PB		4
1U - 1st PB		5
1PL - lobbyPI		6
3D - 3Dn PB		7
3PL - lobbyPI		8
2U - 2nd PB		9
2D - 2nd PB		10
2PL - lobbyPI		11

TYPICAL INTERMEDIATE FLOOR WIRE REQUIREMENTS

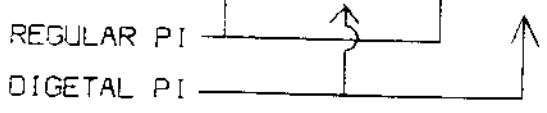
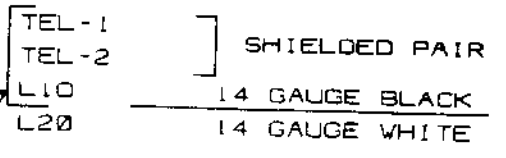

USE WIRE NUTS

MACHINE ROOM TO PUMP UNIT

4 VALVE COIL 3 VALVE COIL

TERM.	DEVICE	WIRE #	TERM.	DEVICE	WIRE #
0H	Dn High Coil		0107	High Coil	
0107	Dn High Coil		HS	High Coil	
0107	Up High Coil				
UH	Up High Coil				
0105	Up Level Coil		0125	Up Level Coil	
8	Up Level Coil		8	Up Level Coil	
0106	Dn Level Coil		0106	Dn Level Coil	
10	Dn Level Coil		10	Dn Level Coil	
2	Thermal O.L.		2	Thermal O.L.	
1	Thermal O.L.		1	Thermal O.L.	

MACHINE ROOM TO STARTER

TERM.	DEVICE	WIRE #
TP12	NC aux. contact	
TP8	NC aux. contact	
TPB	NO aux. contact	
5	NO AUX. CONTACT	
3	Starter O.L.	
2	Starter O.L.	
8	Starter Coil	
0104	Starter Coil	
L1	1 leg of 3 phase	
L2	1 leg of 3 phase	
L3	1 leg of 3 phase	

SPARES
#1-14 CONDUCTOR
7-
8-
#2-14 CONDUCTOR
12-
13-
14-

DELTA ELEVATOR

OS1A4

OUTPUTS

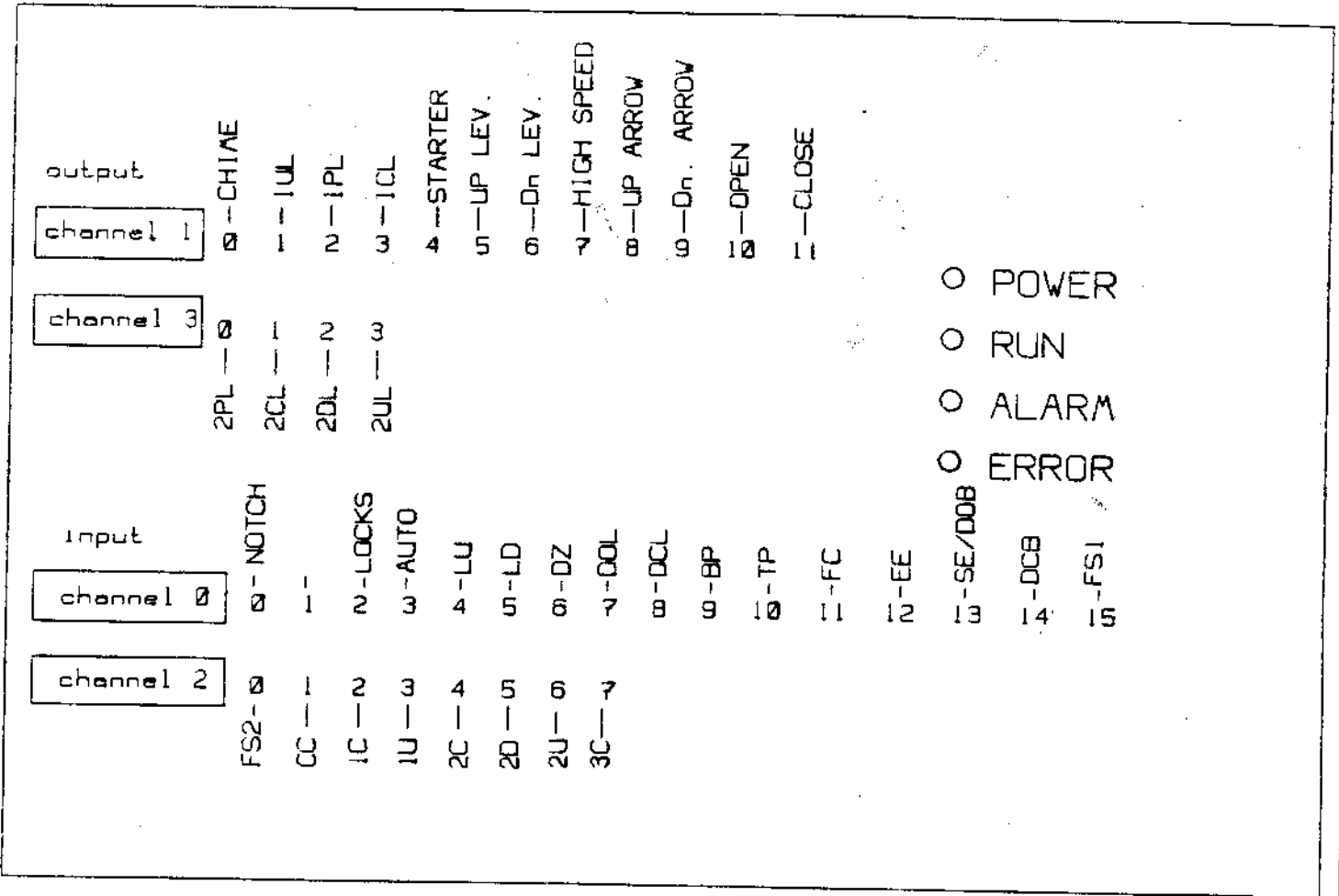
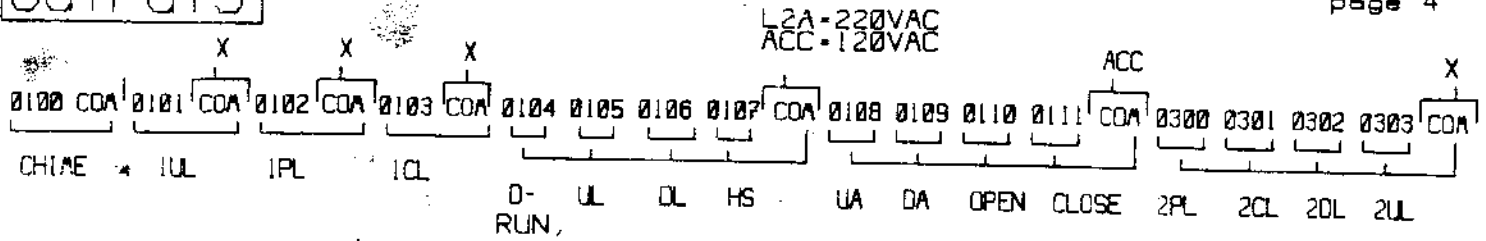

INPUTS

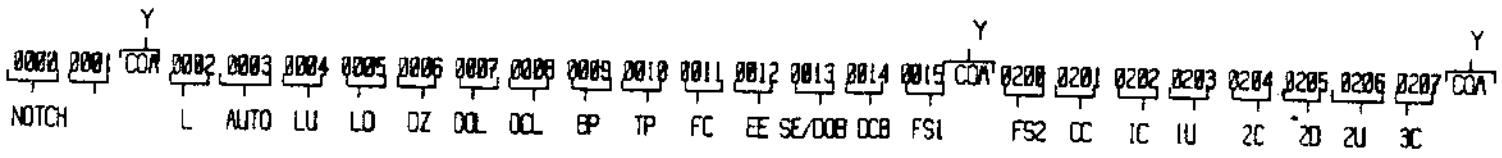

DELTA ELEVATOR

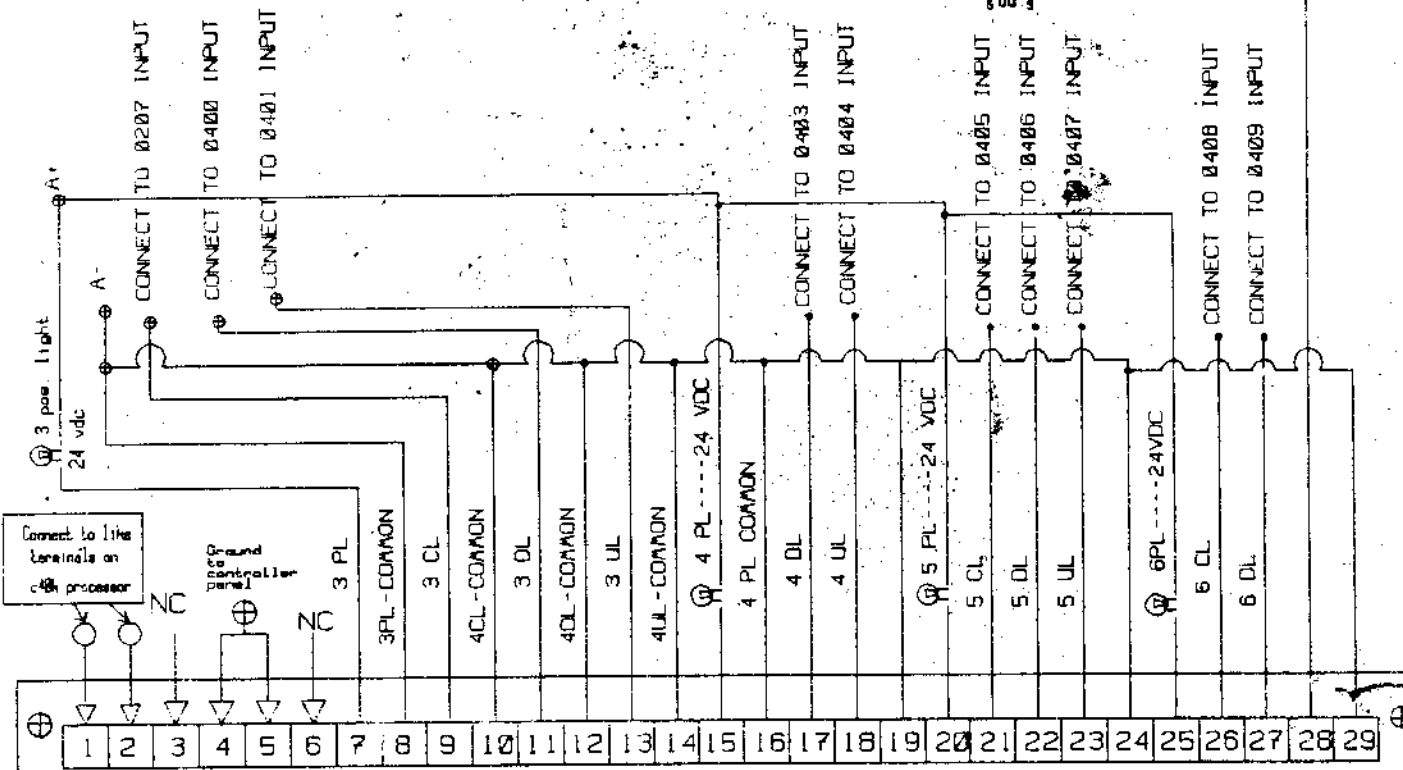

C40P OMRON

NOTE: SEE PAGE

5

